

NEONMINI 60W LED LIGHTS

Product Description

Solid Apollo's LED NeonMini is a state of the art neon LED lighting simulating the effect and look of neon in a thin continuous well balanced light. This next generation bendable LED NeonMini projects brutally bright light offering optimum performance, efficient energy and effortless maintenance over traditional glass neon.

The NeonMini is fully dimmable. It features a soft adaptable and flexible body with a completely diffused light output. This strip is side bending in the opposite direction as the light output and can easily curve and bend to create custom shapes and designs. With an ultra-slim body width of less than a quarter inch, the NeonMini is made to deliver amazing neon effects in subtle and discreet areas such as the inside of crevices, in-wall applications, and long linear lighting.

- Fully Dimmable
- 20ft Spool
- Flexible & Cuttable
- Cut Points Every 2in
- Features a 6.6ft Waterproof Cable w/ Female Barrel Connector
- Low Voltage Product at 24V - 60W Per Spool
- Fully Waterproof, Rated at IP67
- Indoor / Outdoor Application
- Product Comes Ready to Plug & Play
- Perfect for Accent Lighting, Linear Lighting and In-Wall Lighting

Quick Spec.

- **Fully Dimmable:** Yes
- **Voltage:** 24V DC
- **Beam Angle:** 111°
- **LEDs per Foot:** 36
- **Warranty:** 3 Years
- **Dimensions:** 236.2in x 0.23in x 0.47in
- **Working Temperature:** -10° to 140°F
- **Certifications:** UL, RoHS

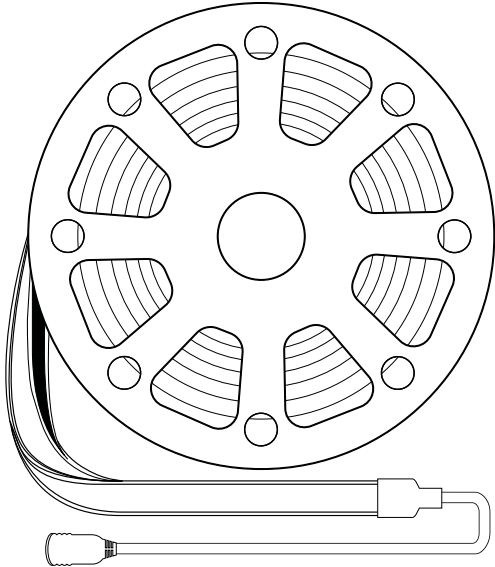

720 LEDs
19.7ft



UP TO 148+
LUMENS / FT

NeonMini LED Illustration

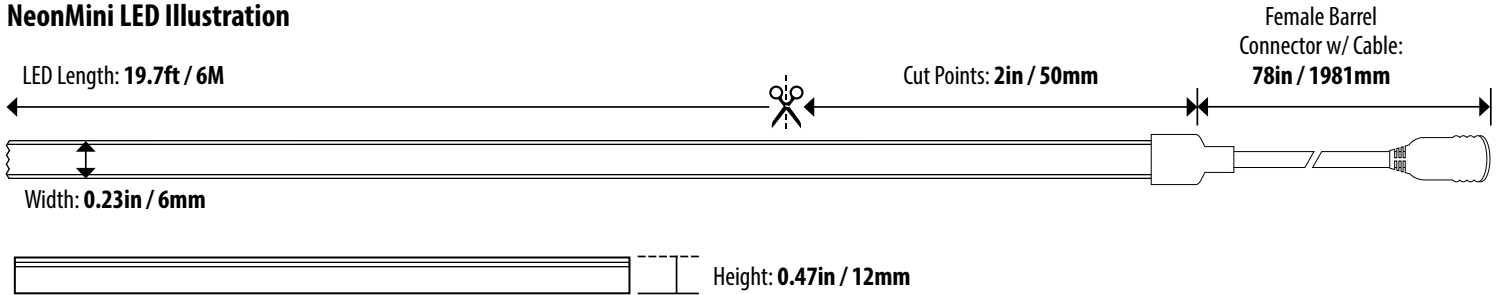

Technical Information

Available LED Color	SKU#	Temp (K)	Lumens / Ft.	LED Type	Total of LEDs	Color Rendering Index	Minimum Cut
Candlelight White	SA-MNLS-CLWW	2400K	134	SMD 2835	720	82+	2in / 50mm
Super Warm White	SA-MNLS-SWW	2700K	134	SMD 2835	720	82+	2in / 50mm
Warm White	SA-MNLS-WW	3000K	137	SMD 2835	720	82+	2in / 50mm
Daylight White	SA-MNLS-DW	4000K	116	SMD 2835	720	82+	2in / 50mm
Natural White	SA-MNLS-NW	5000K	148	SMD 2835	720	82+	2in / 50mm
White	SA-MNLS-W	6000K	140	SMD 2835	720	82+	2in / 50mm
Red	SA-MNLS-RED	Red	N/A	SMD 2835	720	N/A	2in / 50mm
Green	SA-MNLS-GREEN	Green	N/A	SMD 2835	720	N/A	2in / 50mm
Blue	SA-MNLS-BLUE	Blue	N/A	SMD 2835	720	N/A	2in / 50mm
Amber	SA-MNLS-AMBER	Amber	N/A	SMD 2835	720	N/A	2in / 50mm
RGB	SA-MNLS-RGB	RGB	N/A	SMD 3838	720	N/A	2in / 50mm

NEONMINI 60W LED LIGHTS ACCESSORIES

Dimmers and Controllers

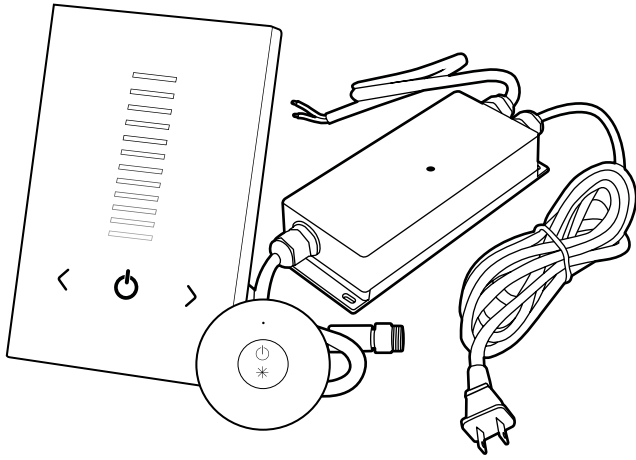

Brackets

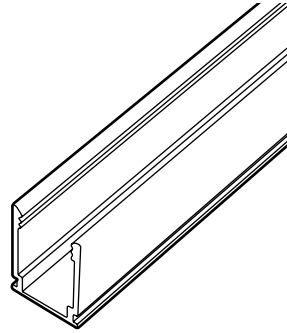

40" Bracket for LED NeonMini
SKU: SA-MNLS-BRACKET-40IN

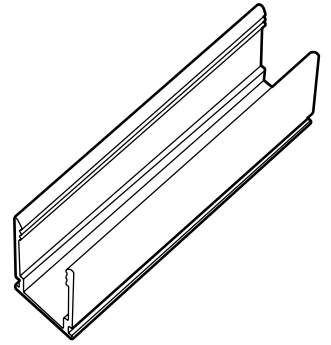

Bracket for LED NeonMini
SKU: SA-MNLS-BRACKET

Power Supplies

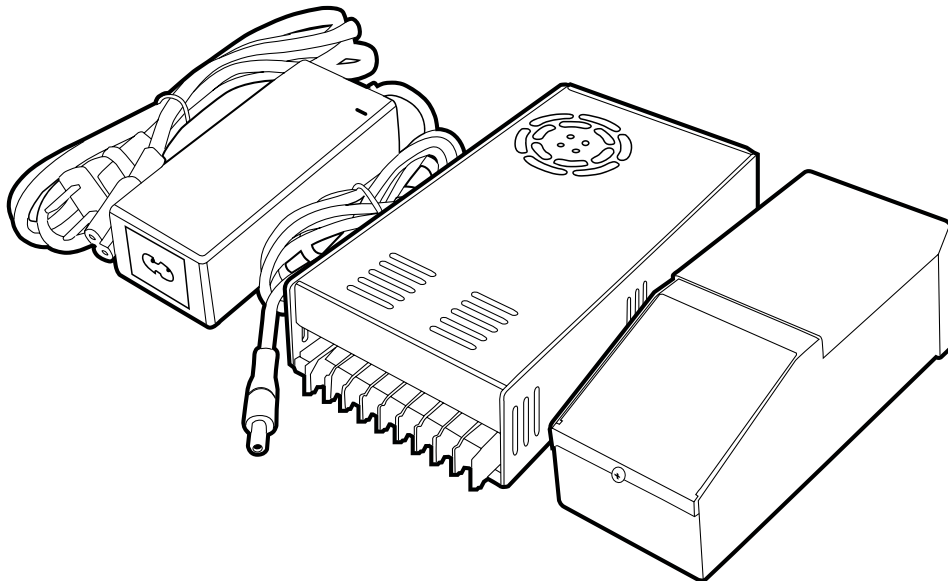

NEONMINI 60W LED LIGHTS INSTALLATION GUIDE

1. Determine where to install the Neon LED.

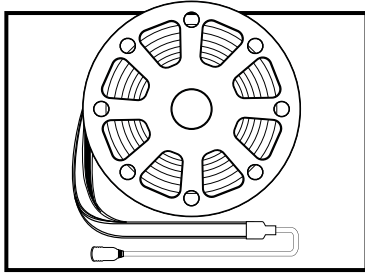

2. Determine the measurement of area where the Neon will be placed.

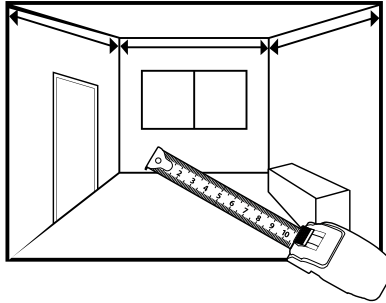

3. If needed, cut additional wire (extending Neon to dimmer).

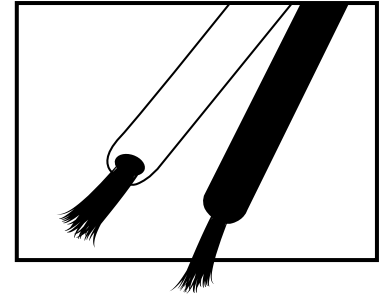

4. A. Cut Neon (at cutting points) to fit or join multiple sections as recommended to cover installation area.

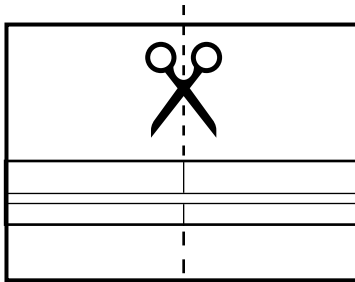

B. If Neon is cut, ensure proper re-waterproofing with an end cap and silicon glue.

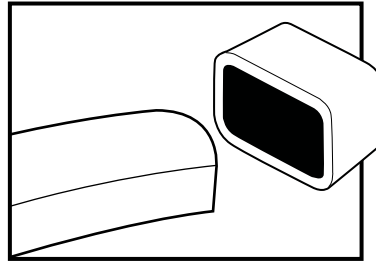

5. If using channels, cut or extend them to fit the size of the installation area.

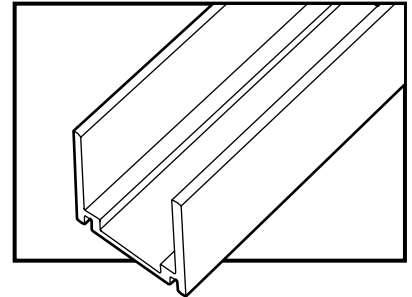

6. Thoroughly clean the surface where the Neon will be mounted.

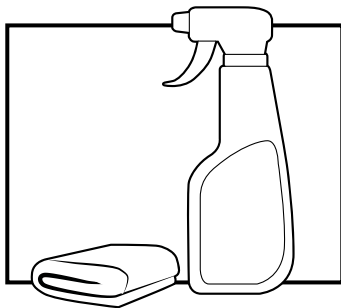

7. If using channels, mount the channel to the surface and gently push the Neon in to the mounted channel.

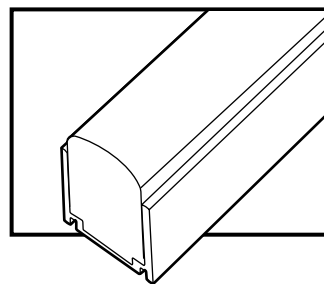

8. Complete the connection/wiring between the plug, optional dimmer, and LED Strips.

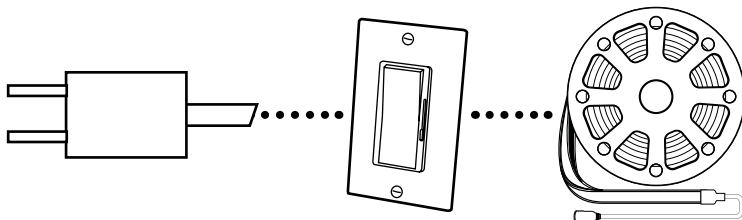

9. Power up and enjoy!

Note: If you have questions and concerns regarding the installation process. Please feel free to contact us at 425.582.7533. We will gladly assist you.

NEONMINI 60W LED LIGHTS WARNINGS

Do not power Neon LED still coiled in spool.

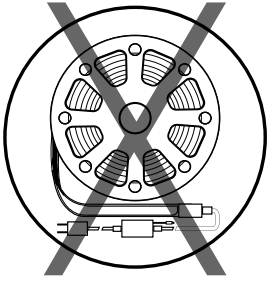

Do not bend Neon LED up and down. This light is **SIDE BENDING** only.

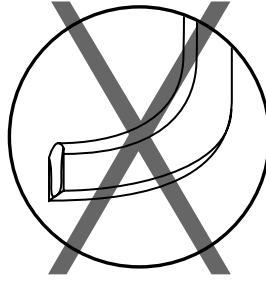

Do not bend Neon LED to a diameter less than .5 inches.

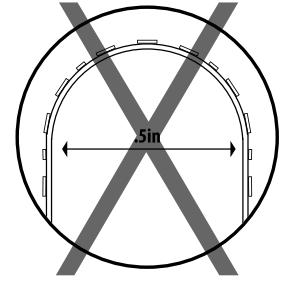

Do not fold or crease Neon LED.

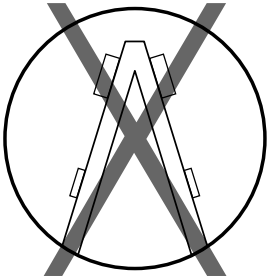

Do not twist Neon LED.

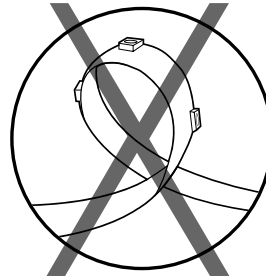

Do not cover Neon LED with anything other than LED Channel Diffusers.

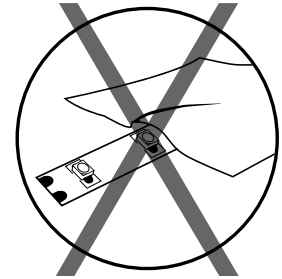

Do not put direct excessive pressure on the Neon LED surface.

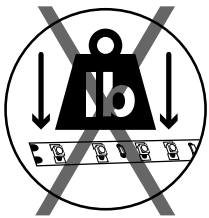

Do not cut Neon LED except at designated cutting points.

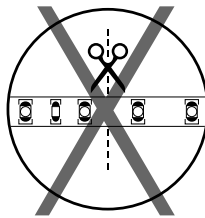

Do not position LED at an angled surface where it is pressed.

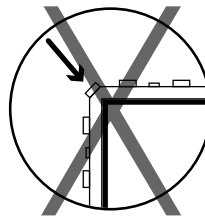

Do not submerge Neon LED lights.

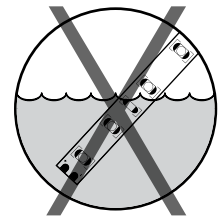

Do not connect or interconnect more than 20 feet (6 meters) of LED Strip to one Power Feed.

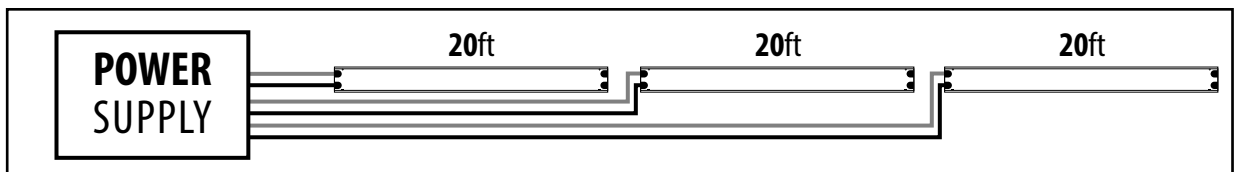
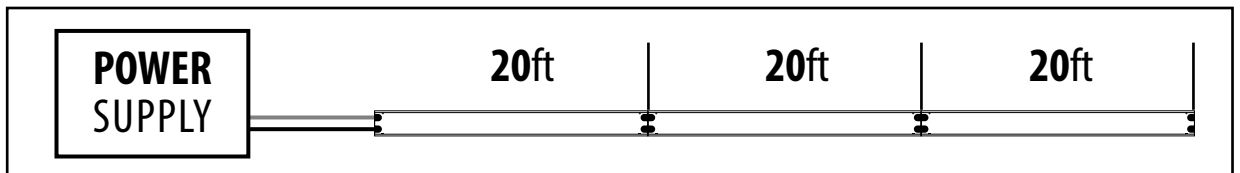

NEONMINI 60W LED LIGHTS SAFETY & WARRANTY

Safety / Disclosures

1. Install in accordance with the proper installation procedure (See pg. 3).
2. Install in accordance with your national or local electrical code regulations.
3. Suitable for wet locations (IP67 Rated).
4. Do not expose to heat more than the specified temperature ratings.
5. Only install with the required Driver/Power Supply – 24V DC Constant Voltage Driver.
6. Use a separate power feed for each recommended maximum run.
7. Only use cables that are certified for use with external connection of electrical equipment and rated for at least 80°C (176°F)
8. Do not mishandle product or modify beyond the guidelines given as this may void product warranty.
9. Only use with the recommended waterproof accessories and ensure complete waterproofing of any modified sections of the strip.
10. Only use the recommended waterproof accessories and wires to connect between LED strip light, driver, controller, and other devices in between.
11. The output color of the LED Strips may have slight variation from that of the pictures on this document or website due to photo rendering limitations.
12. Design improvements and modification of the products could happen from to time and we reserve the right to do these improvements necessary without any prior notice.

Warranty

The **NeonMini** 60W LED Lights come with a 3-year limited warranty from the date it is shipped to the customer. This warranty covers the product as long as it is used for the designed purpose and normally operated unless otherwise stated.

Please visit www.solidapollo.com/returns-amp-warranty.html for the complete warranty details on the product. For any additional questions about product warranty, feel free to contact customer support at 425.582.7533.