

DATA SHEET

DIM TO WARM 2216 50W LED STRIP LIGHT

SKU: SA-LS-DTW-2216-600-24V

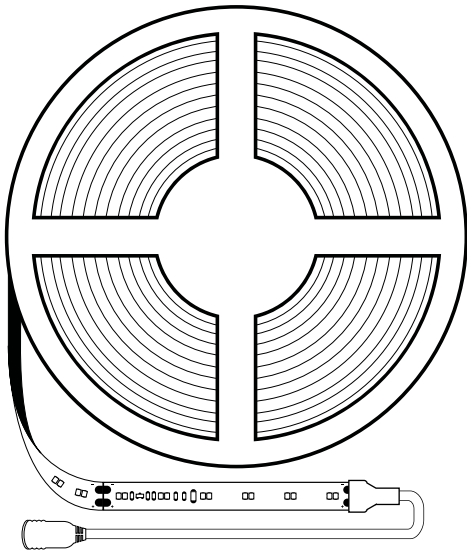

Product Description

Solid Apollo's new Dim to Warm 2216 50W LED Strip Light is a powerful, high quality LED strip that introduces the ability to dim from warm white (3000K) to a warm, cozy ultra warm white (1800K) just like a classic incandescent bulb. Traditional LED strips retain their color temperature as you dim; a daylight white strip still appears as daylight white whether fully lit or dimmed completely to 10%. Dim to Warm allows you to dim the LED strip from a standard warm white to a rich and inviting ultra warm white, creating unmatched ambiance for living spaces, hospitality locations, or anywhere a cozy accent is needed.

The Dim to Warm strip pairs an ultra warm white LED with a white LED. When fully lit, both LEDs are on, blending imperceptibly to create warm white. As the strip is dimmed, the white LED dims first leaving the ultra warm white LED to provide a soft, warm glow. The Dim to Warm strip is controlled with a single color pulse width modulation (PWM) dimmer, despite using dual LEDs to achieve this gorgeous visual effect, making installation a breeze. Simply add any single color PWM dimmer and power source and the strip is ready for installation.

- Easily Dim to Ambient Warm Light
- Fully Adjustable Between ultra warm white and Warm White
- Color: Ultra Warm White 1800K and Warm White 3000K
- Small Cut Points Every 4in
- Includes 5.5in Long Lead Wires for Easy Connecting
- Strong 3M Double Sided Tape
- Great for Creating Cozy Accents and Mood Lighting

600 LEDs
16.4ft

**UP TO 290+
LUMENS / FT**

Quick Spec.

• Dimmable:	Yes, by PWM
• Minimum Cut:	3.9in (100mm)
• Lumens Total:	4450-4750 lm
• Lumens per Foot:	271-290 lm/ft
• LED Color:	Ultra Warm White to Warm White

• Color Temp (k°):	1800K to 3000K
• Color Rendering Index (CRI):	≥90
• Total LEDs:	600
• Voltage:	24V
• Total Wattage:	50W

• Beam Angle:	120°
• PCB Width:	8mm / 0.3"
• Dimensions:	16.4ft x 0.31in x 0.06in
• Working Temperature:	-40° to 122°F
• Certifications:	CE, RoHS

2216 50W LED Strip Illustration

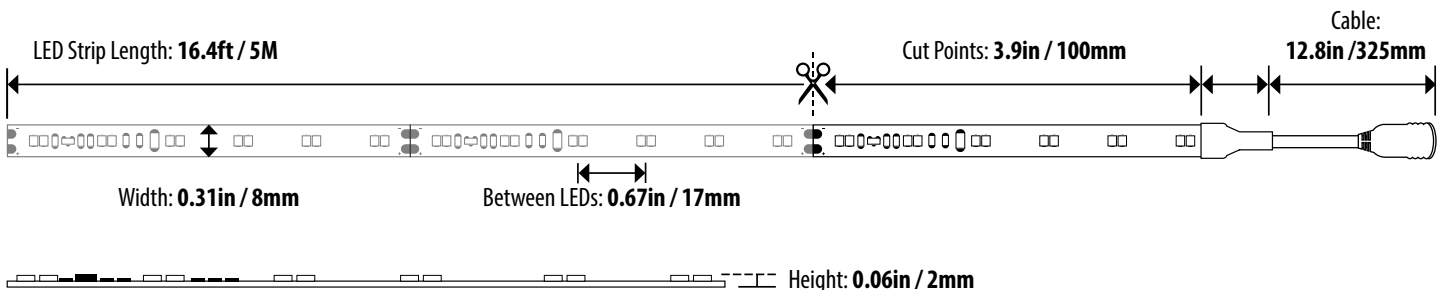

Dimmers

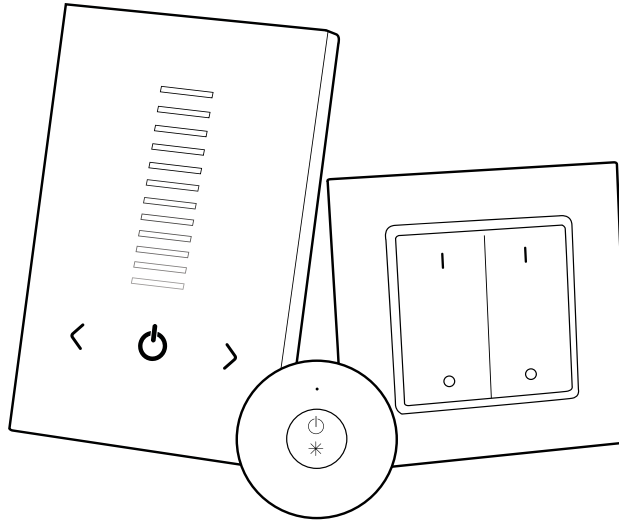

Power Supplies

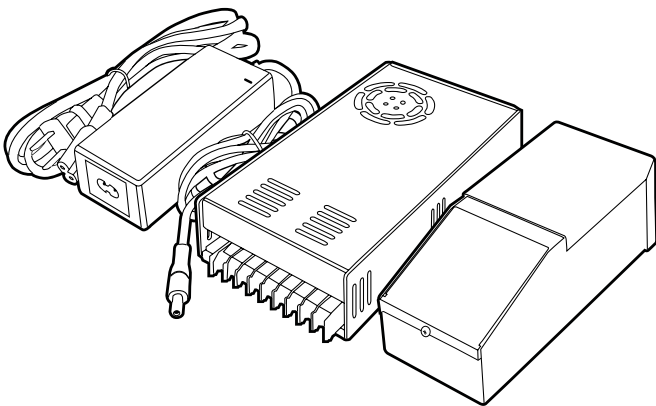

LED Strip Channels

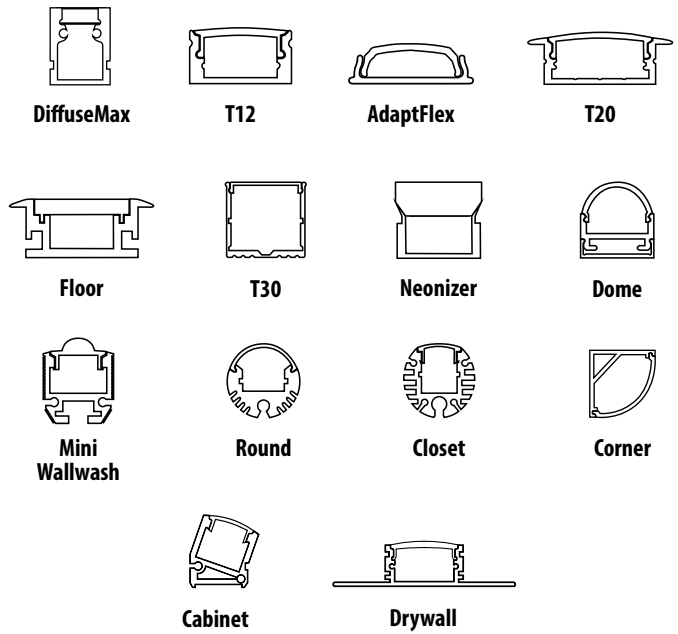

DiffuseMax

T12

AdaptFlex

T20

Floor

T30

Neonizer

Dome

Mini Wallwash

Round

Closet

Corner

Cabinet

Drywall

DIM TO WARM 2216 50W LED STRIP LIGHT INSTALLATION GUIDE

1. Determine where to install the Driver and optional Dimmer.

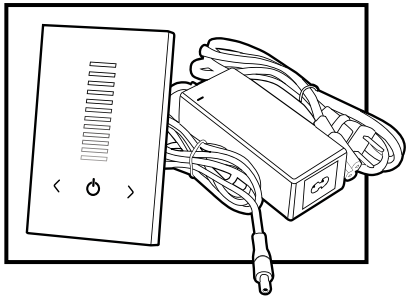

2. Determine the measurement of area where LED Strip Lights will be placed.

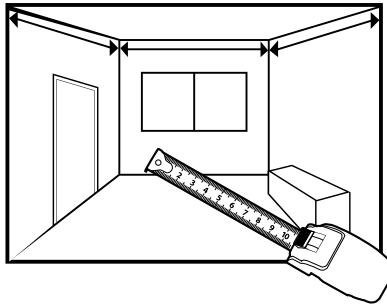

3. Determine how much wire needed (Driver to Dimmer, Dimmer to LED Strips).

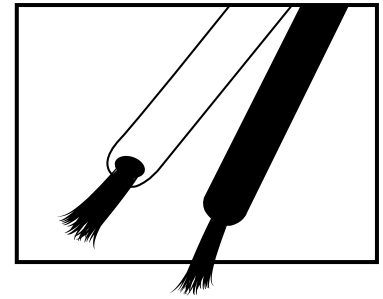

4. Cut LED Strip Lights (at cutting points) to fit or Join multiple Strips as recommended to cover installation area.

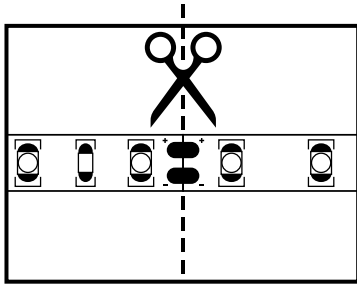

5. If using Channels, cut or extend them to fit size of the installation area

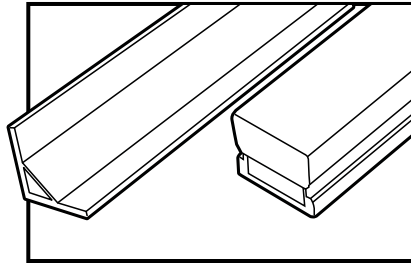

6. Thoroughly clean the surface where the LED Strip will be mounted.

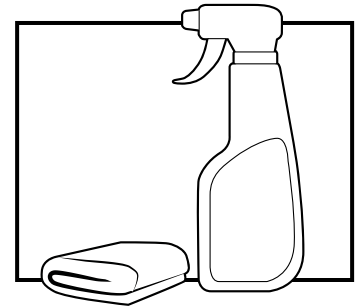

7. A. Peel the 3M Tape cover from the back of the LED Strips and mount it on surface.

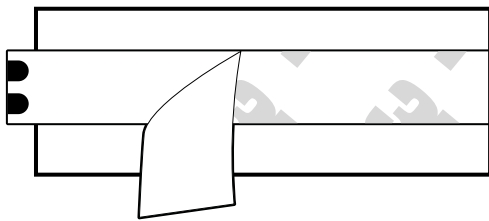

B. If using Channels, mount the LED Strip in the Channel and mount it to the desired surface.

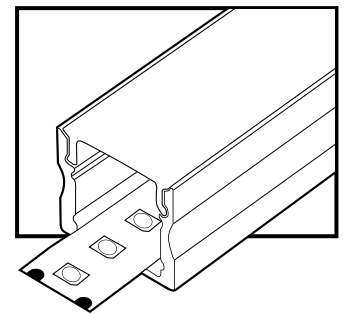

8. Complete the connection/wiring between the Power Supply, optional dimmer and LED Strips.

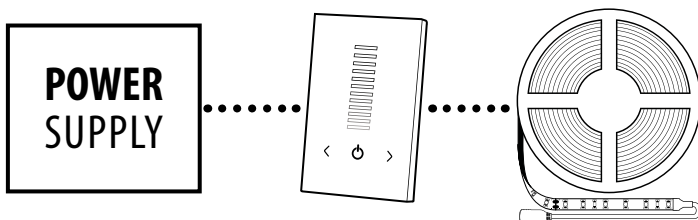

9. Power up and enjoy!

Note: If you have questions and concerns regarding the installation process. Please feel free to contact us at 425.582.7533. We will gladly assist you.

DIM TO WARM 2216 50W LED STRIP LIGHT

Do not power LED Strip still coiled in spool.

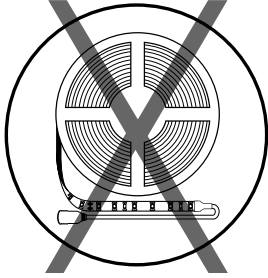

Do not bend LED Strip sideways.

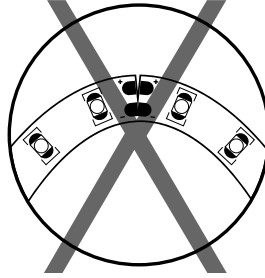

Do not bend LED strips to a diameter less than 1.5 inches.

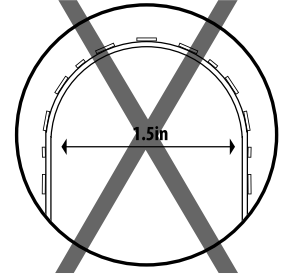

Do not fold or crease LED Strip.

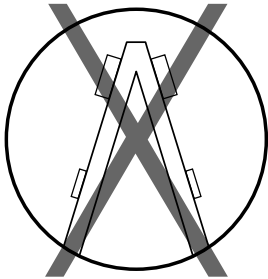

Do not twist LED Strip.

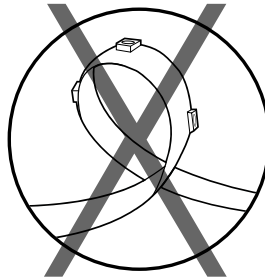

Do not cover LED Strip with anything other than LED Channel Diffusers.

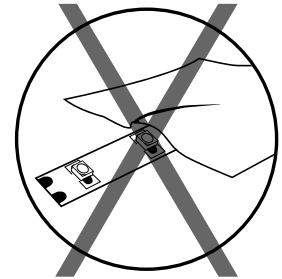

Do not put direct excessive pressure on the LED surface.

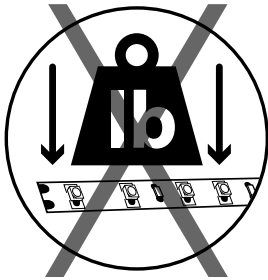

Do not cut LED Strips except at designated cutting points.

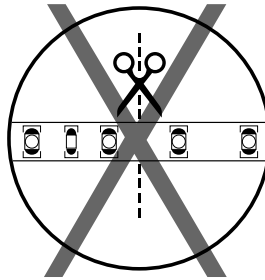

Do not position LED at an angled surface where it is pressed.

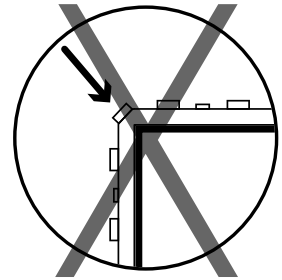

Do not connect or interconnect more than 16 feet (5 meters) of LED Strip to one Power Feed.

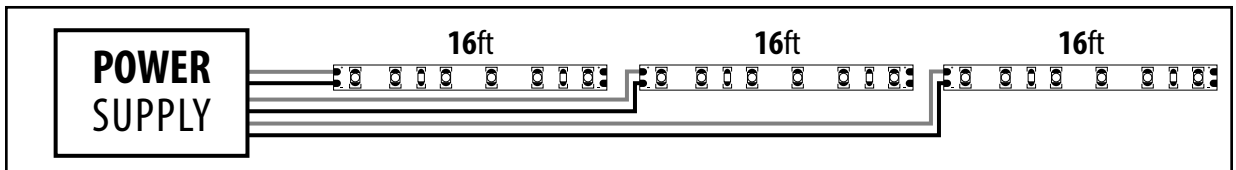
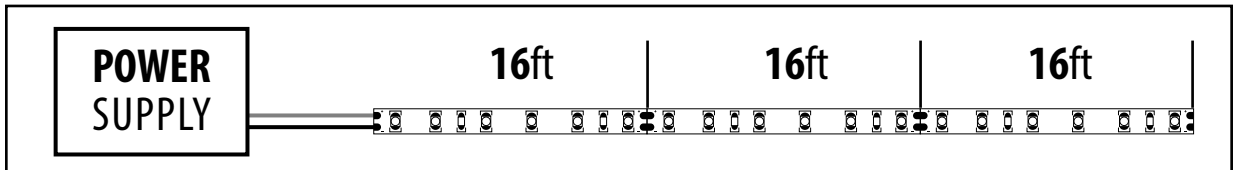

DIM TO WARM 2216 50W LED STRIP LIGHT

Safety / Disclosures

1. Please follow the included installation guide for proper installation procedure (See pg. 3).
2. Install in accordance with your national or local electrical code regulations.
3. Not suitable for wet locations.
4. Do not expose LED chips to direct sunlight continuously.
5. Do not expose to heat more than the specified temperature ratings and do not install too close to stoves, fireplaces, and so on.
6. Only install with the required Driver/Power Supply – 24V DC Constant Voltage Driver.
7. Use a separate power feed for each recommended maximum run.
8. Only use cables that are certified for use with external connection of electrical equipment and rated for at least 80°C (176°F)
9. Do not mishandle product or modify beyond the guidelines given as this may void product warranty.
10. Only use the recommended accessories and wires to connect between LED Strip Light, Driver, Controller, and other devices in between.
11. The output color of the LED Strips may have slight variation from that of the pictures on this document or website due to photo rendering limitations.
12. Design improvements and modification of the products could happen from to time and we reserve the right to implement improvements as necessary without any prior notice.

Warranty

The Dim to Warm 2216 50W LED Strip Lights come with a five year limited warranty from the date it is shipped to the customer. This warranty covers the product as long as it is used for the designed purpose and normally operated unless otherwise stated.

Please visit www.solidapollo.com/returns-amp-warranty.html for the complete warranty details on the product. For any additional questions about product warranty, feel free to contact customer support at 425.582.7533.